

"innovando con las empresas"



Iker Arroyo

Head of In Mould Electronics
Eurecat - Centre Tecnològic de Catalunya
iker.arroyo@eurecat.org

Plastronics

The revolution of Smart Plastics

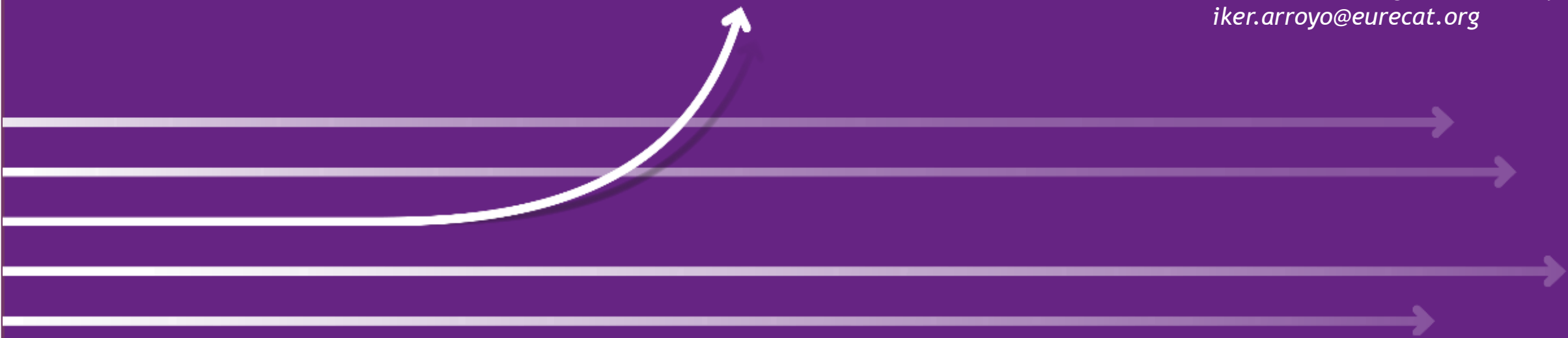

Plastronics

Where do we come from?

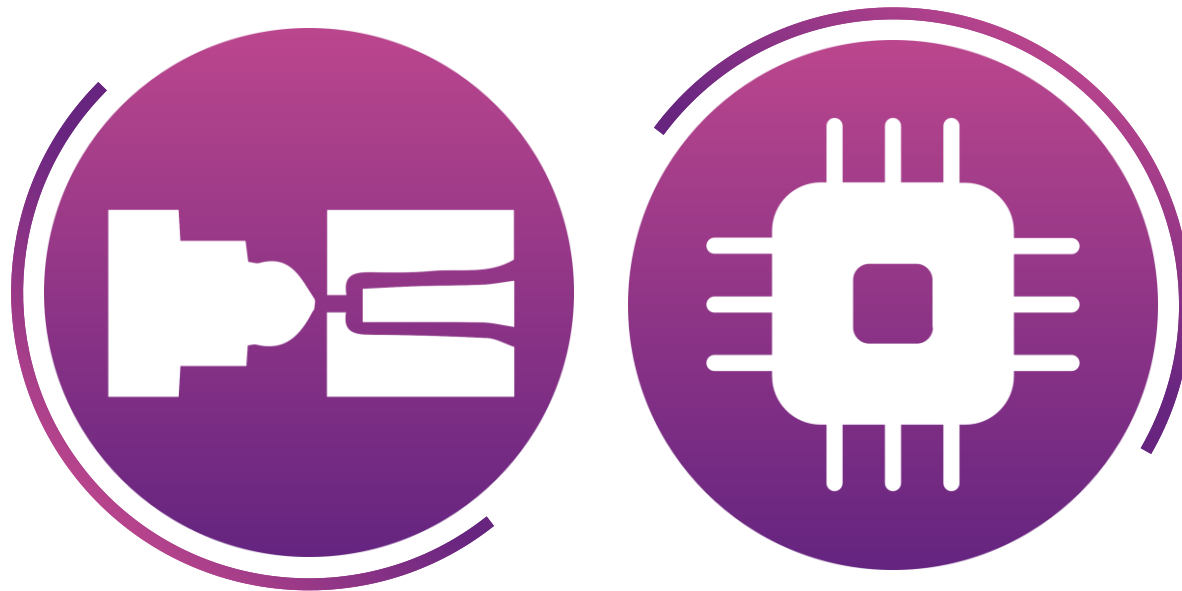

Plastronics

The revolution of Smart Plastics

Plastronics

8 reasons to take the leap



Plastronics

8 reasons to take the leap





Decorative foil

Endless decoration options.

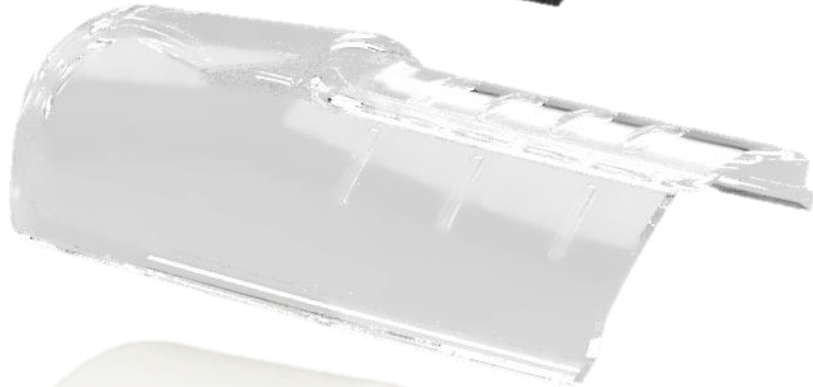

Resin

Structural and encapsulation medium.



Functional foil

Smart functionalities: from illumination to sensing.
Endless combinations.

Plastronics

One part, one process, endless variations



Plastronics part



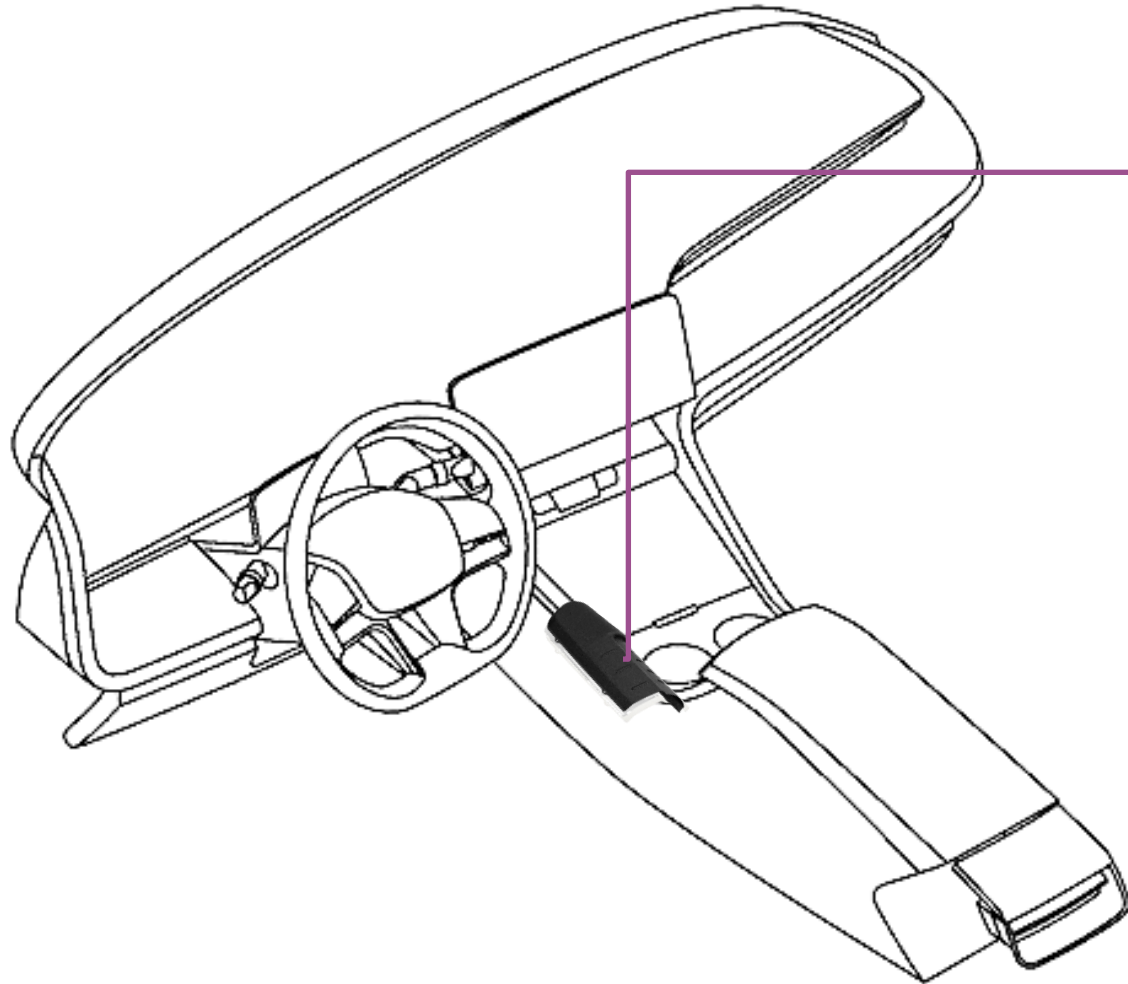

Plastronics center console

- Capacitive switches
- Backlit pictograms
- Intuitive use
- Haptic grooves
- Seamless design

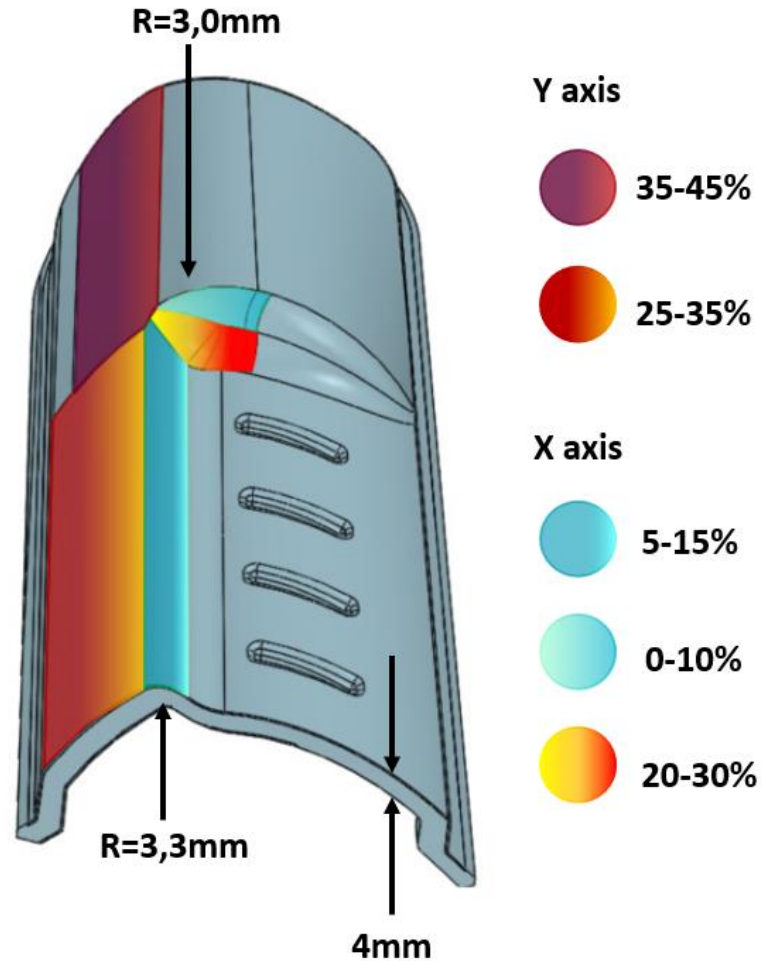

Preserve the geometry

Small radiuses

2D stretching (X & Y axis)

High formation ratio

Use of proper materials and manufacturing strategies

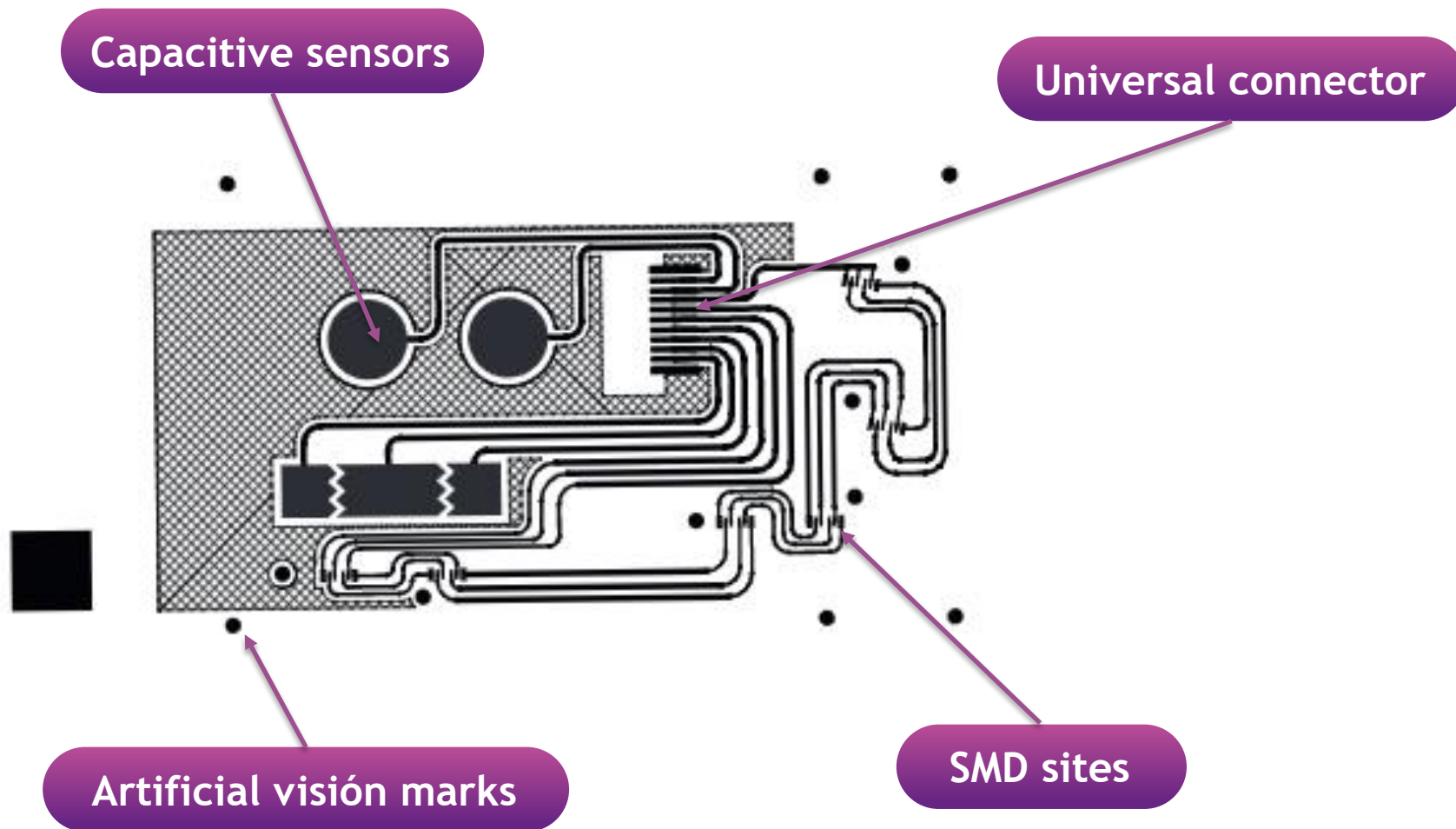

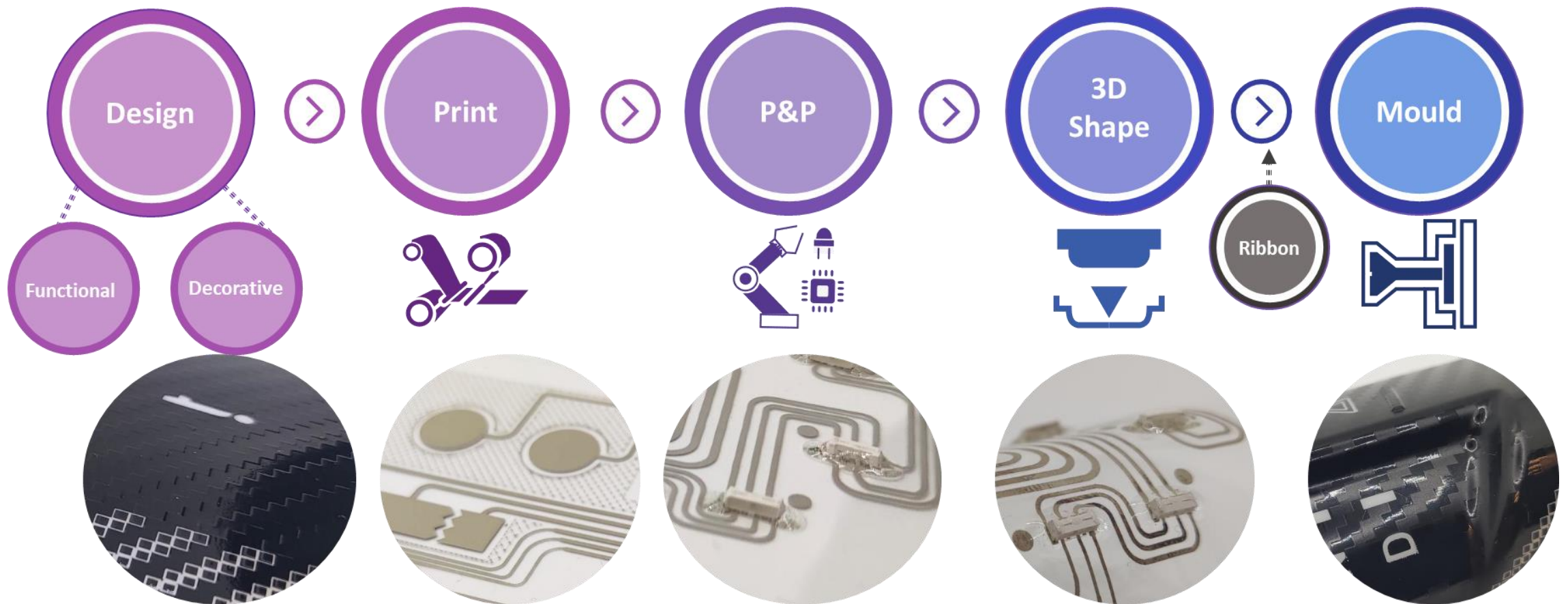

Our value

From A to Z

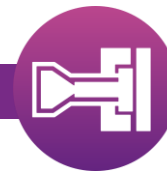
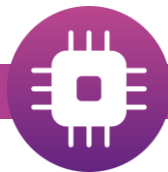

Tailor-made design

Screen printing

Hybridization

Forming

Trimming

Injection moulding

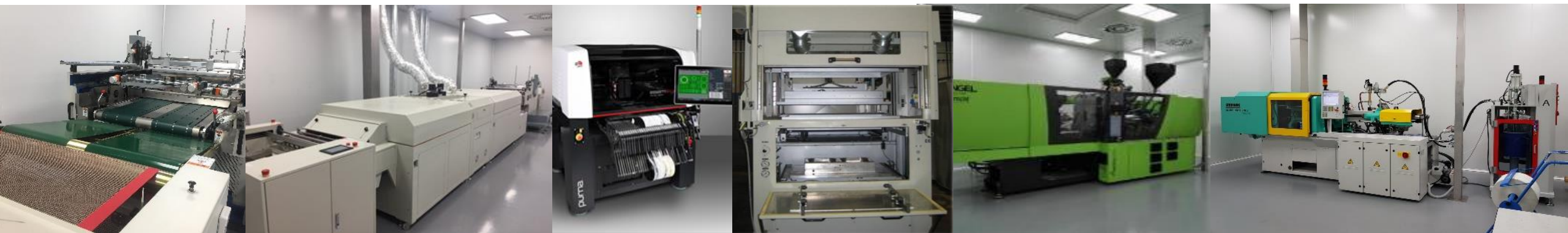

Plastronics pilot plant



Design and validation
of functional film

Design and validation
of decorative film

Full functional
decorated part

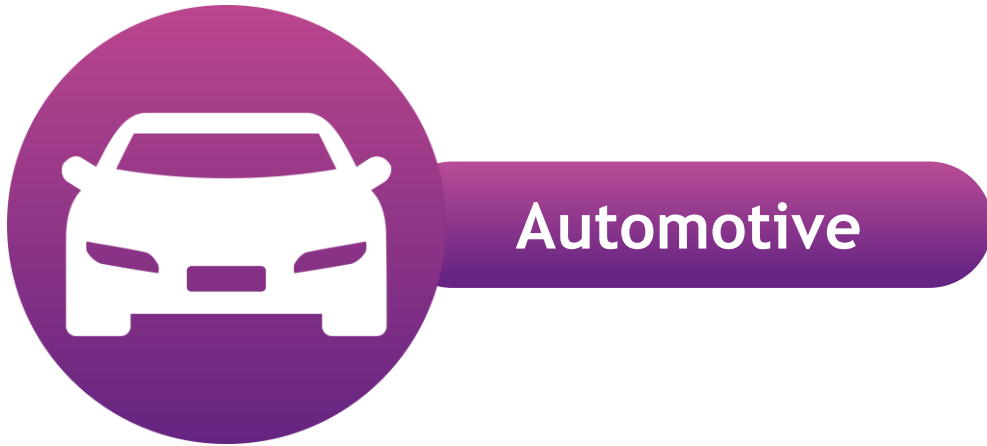

14+
projects with end users

5
ongoing projects with end users

3+
consortium projects

6
innovative solutions
susceptible of patent

6+
years of experience

Welcome

Innovating with business



Welcome

Innovating with business

eurecat



Plastronics

The revolution of Smart Plastics



Iker Arroyo

Head of In Mould Electronics
Eurecat - Centre Tecnològic de Catalunya
iker.arroyo@eurecat.org

Plastronics

The revolution of Smart Plastics

